

SAXON Fitting Instructions

Aluminium Radiator in White
Horizontal and Vertical

Please read these instructions and terms and conditions carefully prior to installation. Failure to do so may invalidate the warranty.

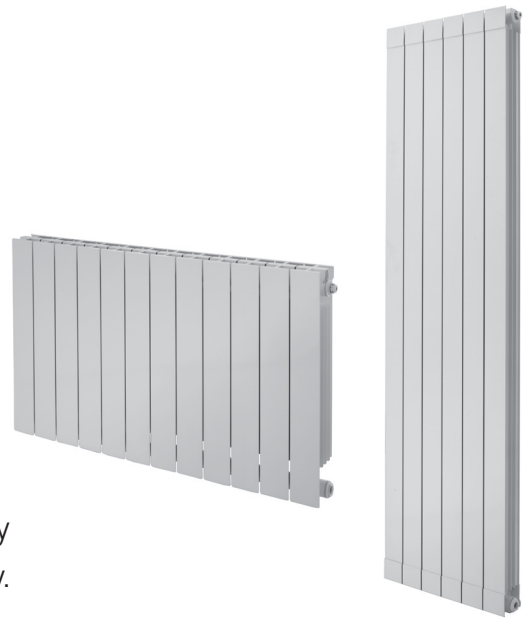

Drawings

Drawing 1 - Bush Configurations

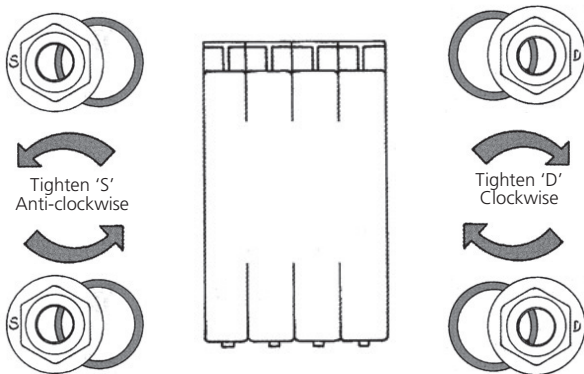

SAXON radiators have specific left and right hand threaded bushes and these can be easily damaged if forced or incorrectly fitted (this will inevitably cause leaks). **Bushes require a dry fit connection only; you must not use any Compound materials (e.g. Jet Blue) or Plumbers Hemp.** If you choose you may use up to 4 turns of PTFE tape to help seal the threads (the tape should be applied in the direction of the thread and no more than this amount should be used as this may cause leaks to occur)

If looking directly at the front of the radiator, the two bushes with an 'S' cast on them are positioned on the left and turned anti-clockwise. The two bushes cast with a 'D' are positioned on the right and turned clockwise. **Please see Drawing 1**

Drawing 2 - Bracket Positions

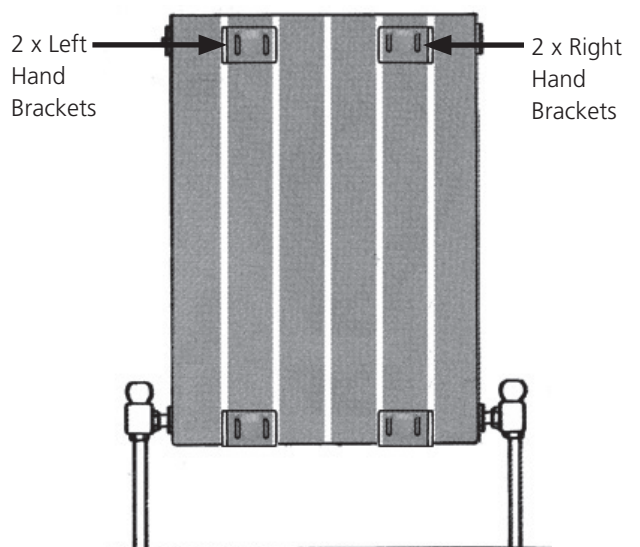

Pipe Centres

Pipe centres left to right	=	width of radiator plus valves
Pipe centres from wall	=	70mm
Depth from wall	=	120mm

1. Unpack & Inspect

This product should have reached you in perfect condition. Please carefully unpack and inspect this radiator and all fittings. Your point of purchase must be notified of any shortages or damage within 28 days of delivery. For further information please see terms and conditions on reverse.

2. Contents

You should have:

- 1 Radiator
- 4 Wall Brackets
- 1 Manual Airvent
- 4 Bushes with Gaskets
- 1 Blanking Plug
- 1 Diverter (for 1400mm vertical models only)

You will need:

- Tape measure
- Electric drill and bits
- Spirit level
- Bush spanner

3. Fit Diverter

Aluminium radiators which are 1400mm tall are supplied with a Spring Diverter, which is installed in the lower waterway at either end.

This is installed by pushing the cap firmly in the waterway until it locates against the barell nipple and is retained in place by the bush. The flow must enter this end first (please see drawing A below).

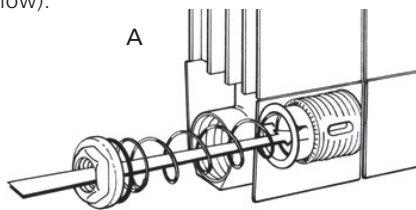

4. Fix Brackets

You will have been supplied with at least four brackets (see drawing 1 on other page and drawing B below). The brackets are typically positioned one section in from either end with extra brackets spaced at equal distances between these two (see drawing 2 on the other page).

Brackets should be fixed using suitable drill bit, screws and plugs.

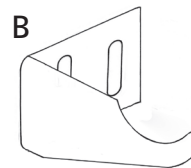

PLEASE NOTE:

It is essential that all brackets are level and square prior to hanging the radiator to ensure a vertical alignment for connecting the pipework.

Mark and fix the 2 top brackets checking they are level. Hang radiator in position and mark the location of the 2 bottom brackets and fix in place.

5. Hang & Commission Radiator

With the brackets firmly fixed and level, the radiator is lowered directly onto the brackets. When commissioning your radiator on an indirect/closed system we recommend using a suitable quality and quantity of mixed metal inhibitor to protect against scale & corrosion.

Damage caused to systems not protected by a suitable inhibitor will not be covered by manufacturer's guarantee.

Technical Specifications

Materials	Aluminium.
Connections	½" flow and return.
Test pressure	9 Bar
Testing authority	EN442
Maximum operating pressure	6 Bar
Maximum working temperature	110°C
Packaging	Wrapped in polythene & boxed.

PLEASE NOTE: To reduce the possibility of noise caused by rapid heating and cooling of aluminium radiators; adequate capacity for expansion must be provided within the overall heating system. Systems using micro bore pipework must have adequate pressure and flow rates for the number and style of radiators on the system.

Guarantees & Liabilities

This product is guaranteed for 10 years. As we are not the manufacturers of this product we will take all reasonable endeavours to make over to you the benefit of any warranty or guarantee given by the manufacturer.

The guarantees in all cases are subject to the products being installed in accordance with British and or European standards as well as these fitting instructions. The guarantees in all cases are restricted to the free of charge replacement or repair of the failed product only. Our liability will under no circumstances extend beyond the repair or replacement of the product supplied by us. Claims for either labour in replacement or damage to property are not admissible. Any goods that are returned, in the event of a problem, will belong to us.

Terms & Conditions

All products must be inspected once removed from the packaging and your point of purchase notified within 28 days of delivery of any scratches, blemishes or other damage. Your point of purchase will then agree appropriate action. Imperfect radiators should therefore not be fitted and we will not accept responsibility for replacement of scratched or damaged radiators once they have been fitted. This includes any consequential loss or cost of fitting.

If we are not notified within 28 days of the date on the signed delivery note then it will be deemed that we have fully complied with our obligations and claims will not be considered.

Failure to comply with any of the above may invalidate any claims. We recommend that after you check the product on delivery that it is stored in its packaging to prevent damage prior to installation, we cannot accept responsibility for items damaged after delivery.

For full details of our Terms and Conditions please visit www.supplies4heat.co.uk or call us on 01342 306880.